

**Electro-Voice®**  
a MARK IV company

# Model HP9040 Constant-Directivity Horn

## SPECIFICATIONS

The following specifications are in accordance with or exceed the AES Recommended Practice for Specification of Loudspeaker Components Used in Professional and Audio Sound Reinforcement (AES2-1984; ANSI S4.26-1984).

**Horizontal Beamwidth:**  
90° (+20°, -20°)  
(-6 dB, 400 Hz to 20 kHz)

**Vertical Beamwidth:**  
40° (+20°, -10°)  
(-6 dB, 500 Hz to 20 kHz)

**Directivity Factor  $R_\theta$  (Q):**  
12.1 (average 500 Hz to 20 kHz)

**Directivity Index  $D_i$ :**  
10.8 dB (+1.4, -1.6)  
10 log  $R_\theta$ , (average 500 Hz to 20 kHz)

**Usable Lower Frequency Limit:**  
500 Hz

## Construction:

Polyester resin and glass-fiber laminate integrally molded to a die-cast zinc throat section. This hybrid construction assures a rigid driver mount, accurate, loss-free throat-wave transmission and low total weight compared to horns of similar size.

## Mechanical Connection of Driver:

Bolt on; standard 2"-diameter throat, 5"-diameter mounting flange and four clearance holes for 1/4" bolts on a 4"-diameter bolt circle.

## Recommended Drivers:

DH1  
DH2

## Dimensions:

67.9 cm (26.8 in.)  
81.3 cm (32.0 in.)  
80.6 cm (31.8 in.)

## Weight:

9.1 kg (20.0 lb)

## Shipping Weight:

14.1 kg (31.0 lb)

## DESCRIPTION

The Electro-Voice model HP9040 is a wide-range, flat-front, high-frequency, constant-directivity horn. It offers economy of space, where its geometry is "just big enough for the job." The horizontal angle is controlled over a frequency range of 400 Hz to 20 kHz and the vertical angle is controlled from 500 Hz to 20 kHz, both with unusual precision and adherence to the intended angle. Furthermore, excellent loading is maintained to a low frequency of 500 Hz. The HP horns' represents the latest development in "CD" horn design, employing the same principles which EV engineers developed and used to design the world's first true constant-directivity horns in 1974. The flat-front design makes the HP9040 suitable for all modern boxed and clustered systems. A unique, lightweight, integral fiberglass-and-zinc construction gives acoustical and mechanical advantages (see Construction section). Lastly, a special vaned waveguide throat detail gives the HP9040 unusually good high-frequency control, vertically, when compared to similar 2-inch-throat horn designs.

1. Patent pending.

$R_\theta$  and  $D_i$  vs Frequency  
(one-third-octave bandwidths)

Freq. (Hz)	$R_\theta$	$D_i$ (dB)	Freq. (Hz)	$R_\theta$	$D_i$ (dB)
500	11.4	10.6	4,000	10.0	10.0
630	14.7	11.7	5,000	9.4	9.7
800	15.3	11.8	6,300	9.2	9.6
1,000	14.8	11.7	8,000	8.4	9.2
1,250	13.3	11.2	10,000	9.8	9.9
1,600	12.2	10.9	12,500	12.8	11.1
2,000	12.5	11.0	16,000	13.0	11.1
2,500	10.4	10.2	20,000	16.7	12.2
3,100	11.0	10.4			

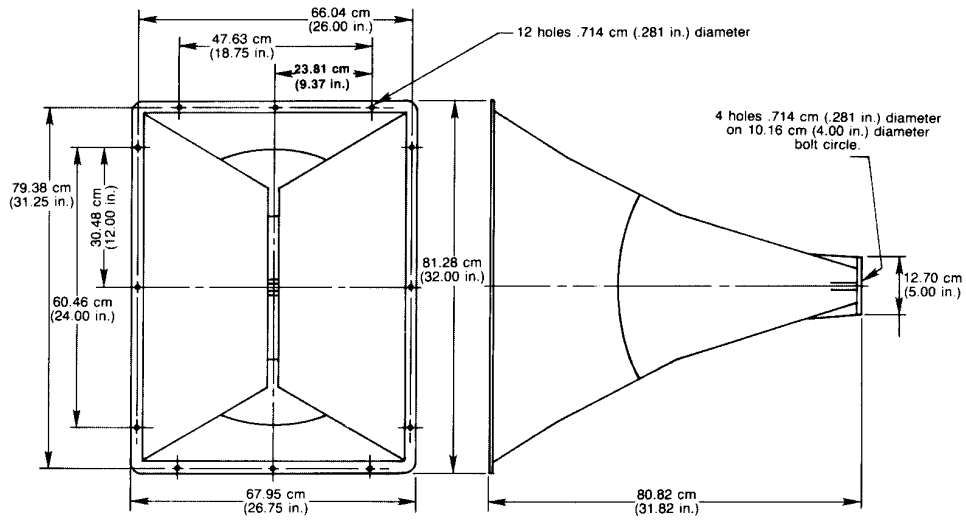

FIGURE 1 — Dimensions

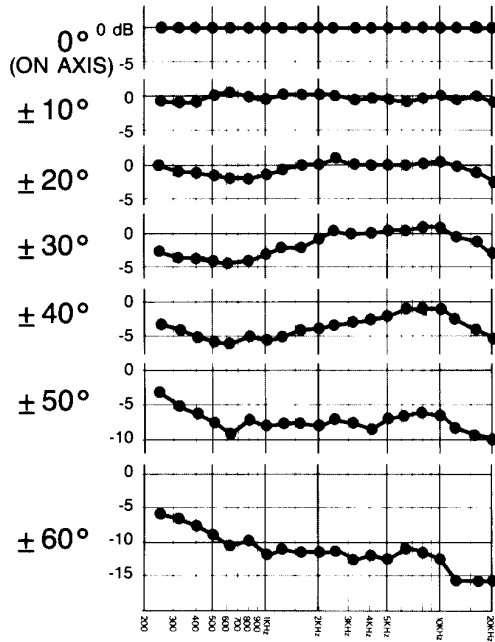

FIGURE 2  
Horizontal Off-Axis Response

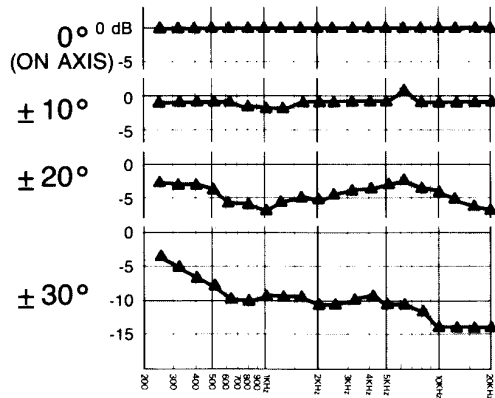

FIGURE 3  
Vertical Off-Axis Response

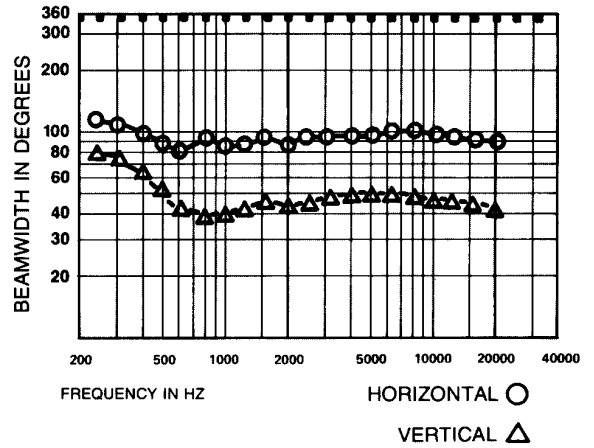

FIGURE 4  
6-dB-Down Beamwidth versus Frequency

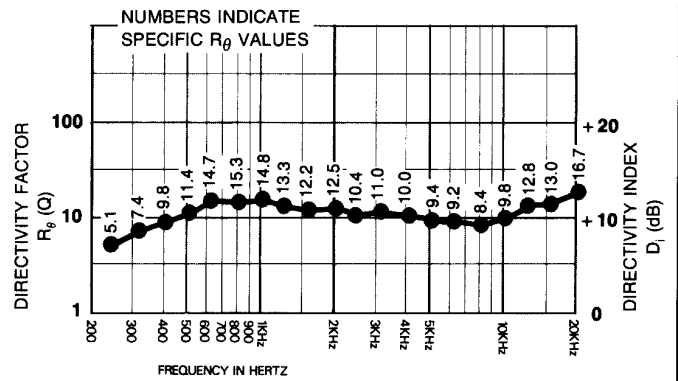
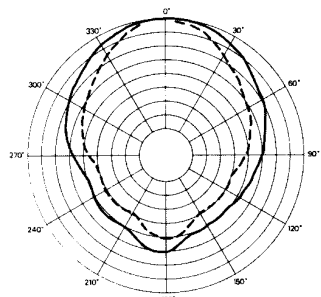
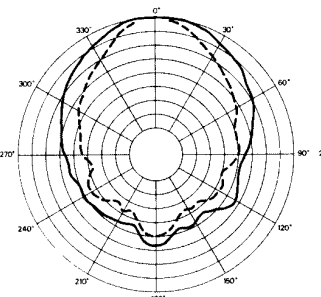

FIGURE 5  
Directivity versus Frequency



**500HZ**



**630Hz**

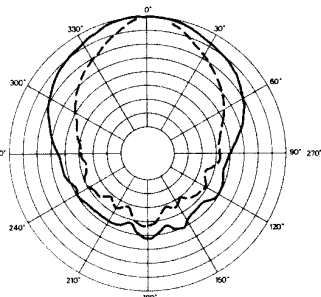

**800Hz**

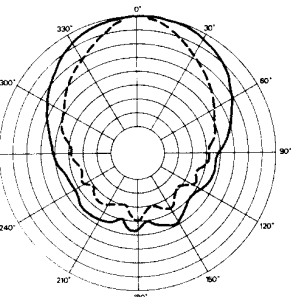

**1kHz**

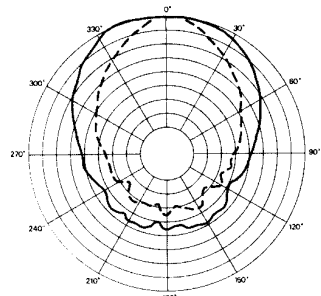

**1.25kHz**

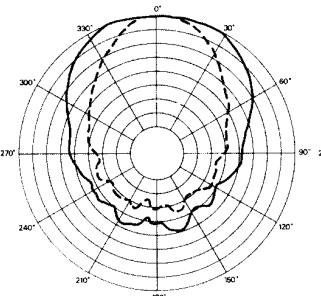

**1.6kHz**

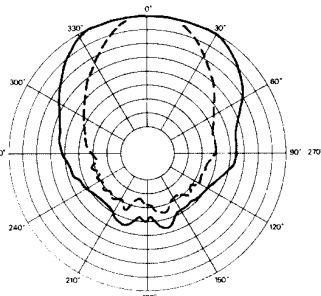

**2kHz**

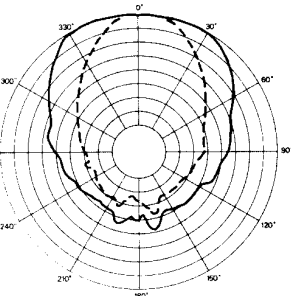

**2.5kHz**

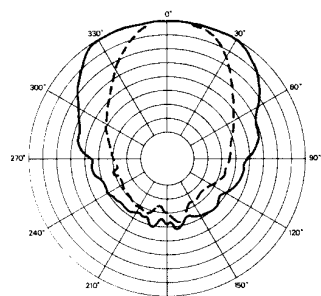

**3.15kHz**

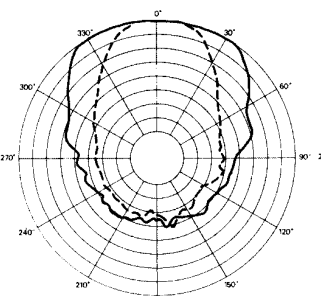

**4kHz**

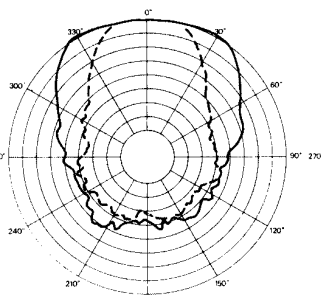

**5kHz**

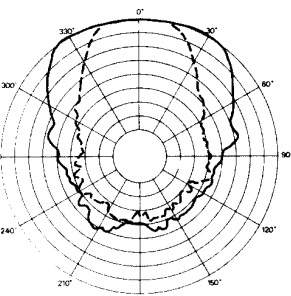

**6.3kHz**

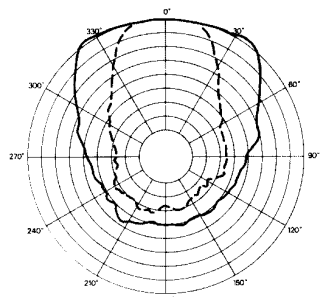

**8kHz**

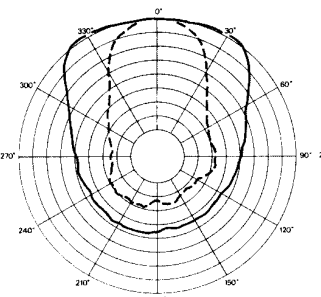

**10kHz**

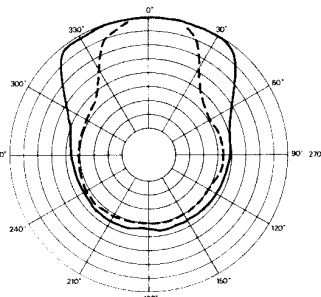

**12.5kHz**

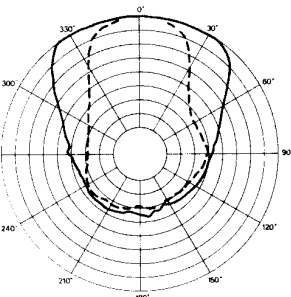

**16kHz**

Scale is 5dB per division

HORIZONTAL ———

VERTICAL - - - - -

**FIGURE 6 — Polars**

frequency. The horizontal beamwidth is maintained at 90° (+20°, -20°) over the range 400 Hz to 20 kHz. Vertical beamwidth is maintained at 40° (+20°, -10°) over the range 500 Hz to 20 kHz.

#### FREQUENCY RESPONSE ON AND OFF AXIS

The one-third-octave frequency response of the HP9040 at various on- and off-axis angles, was derived from the accompanying polars and is displayed in Figure 2 and Figure 3. All curves are referenced to the on-axis level. These responses illustrate the curves one would get with a real-time spectrum analyzer at the different angles if the horn/driver were equalized flat on axis, in an anechoic environment.

#### POLAR RESPONSE

The directional characteristics of the HP9040 with driver attached were measured by running a set of horizontal/vertical polar responses, in EV's large anechoic chamber, at each one-third-octave center frequency. The test signal was one-third-octave pseudo-random pink noise (1.0 Hz repetition rate)

and the bottom angle is the vertical beamwidth (---).

#### ARCHITECTS' AND ENGINEERS' SPECIFICATIONS

The horn shall be of the constant-directivity type. It shall produce a horizontal beamwidth (6-dB-down angle) of 90 degrees, deviating no more than 10 degrees from this angle over the frequency range 400 to 2,000 Hz. It shall produce a vertical beamwidth of 40 degrees, deviating no more than 10 degrees from this angle over the frequency range 1,500 to 20,000 Hz. In addition, it shall provide useful acoustic loading at all frequencies above 500 Hz.

The horn shall be of hybrid fiberglass-and-zinc construction. The driver-mounting flange and initial throat section shall be constructed of die-cast zinc and shall be integrally laminated into the fiberglass portion of the horn.

The horn shall possess a throat of 4.92-cm (1.94-in.) diameter and its flange shall be provided with four 1/4-20-clearance bolt holes on a 10.2-cm (4.0-in.) circle for the mounting of the compression driver. The horn shall be

to finish, appearance items, burned coils, or malfunction due to abuse or operation under other than specified conditions, including cone and/or coil damage resulting from improperly designed enclosures, nor does it extend to incidental or consequential damages. Some states do not allow the exclusion or limitation of incidental or consequential damages, so the above exclusion may not apply to you. Repair by other than Electro-Voice or its authorized service agencies will void this guarantee. A list of authorized warranty service agencies is available from Electro-Voice, Inc., 600 Cecil Street, Buchanan, MI 49107 (AC/616-695-6831); or Electro-Voice West, 8234 Doe Avenue, Visalia, CA 93291 (AC/209-651-7777). This warranty gives you specific legal rights, and you may also have other rights which vary from state to state.

Service and repair address for this product: Electro-Voice, Inc., 600 Cecil Street, Buchanan, Michigan 49107.

Specifications subject to change without notice.



**ELECTRO-VOICE, INC., 600 Cecil Street, Buchanan, Michigan 49107**

MANUFACTURING PLANTS AT ■ BUCHANAN, MI ■ NEWPORT, TN ■ SEVIERVILLE, TN ■ OKLAHOMA CITY, OK ■ GANANOQUE, ONT.  
©Electro-Voice Inc. 1991 ■ Litho in U.S.A. Part Number 530635-615

a MARK IV company